

# Örnek 1

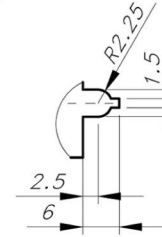

Not: L1H25 NSK Ray'a göre yapılmıştır.

## Örnek 2

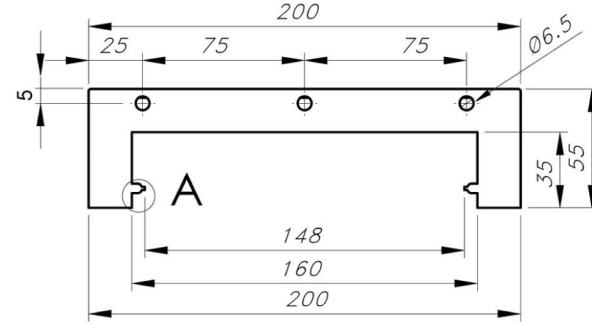
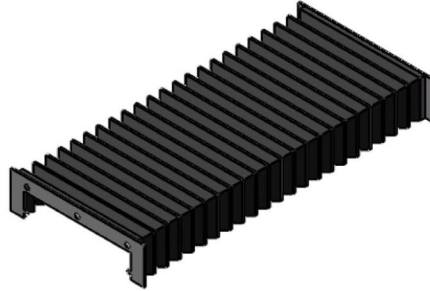
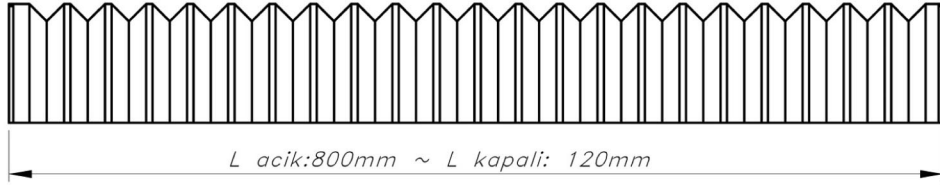
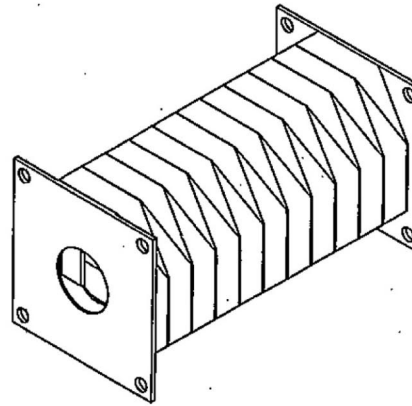
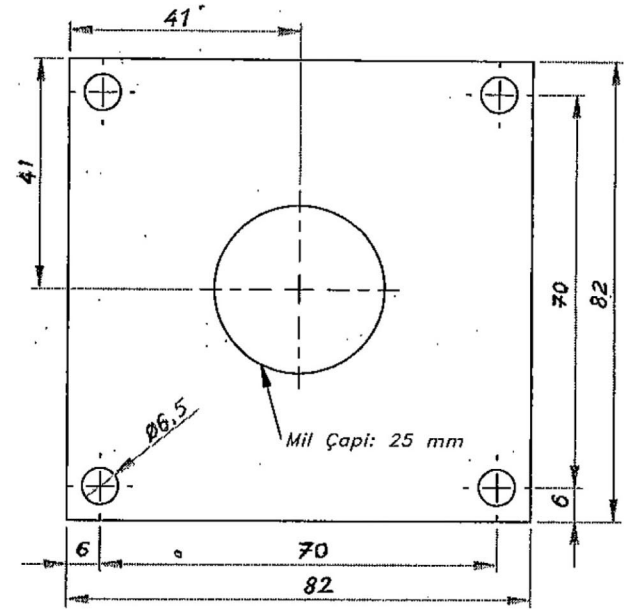
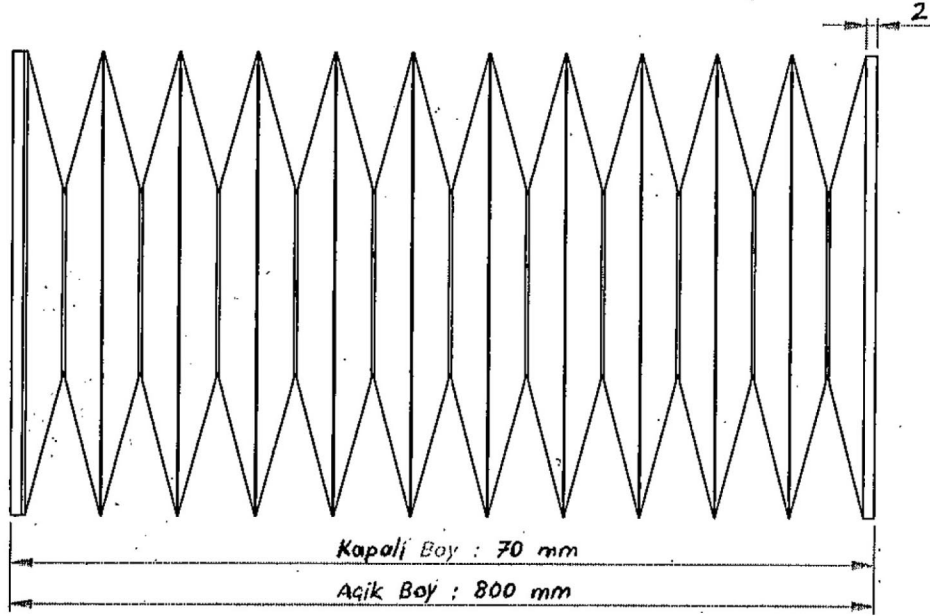

## Örnek 3

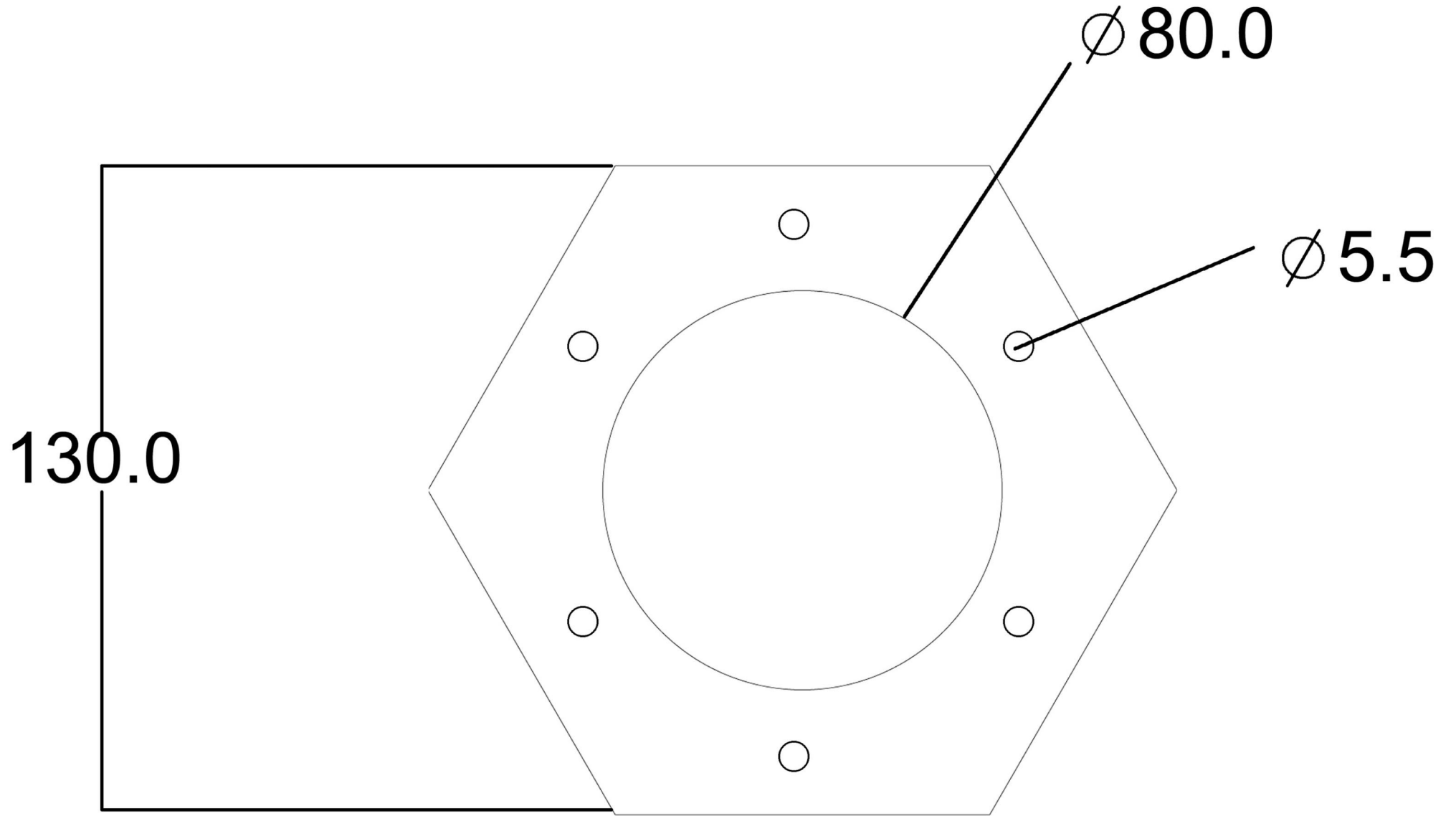

# ÖRNEK 4

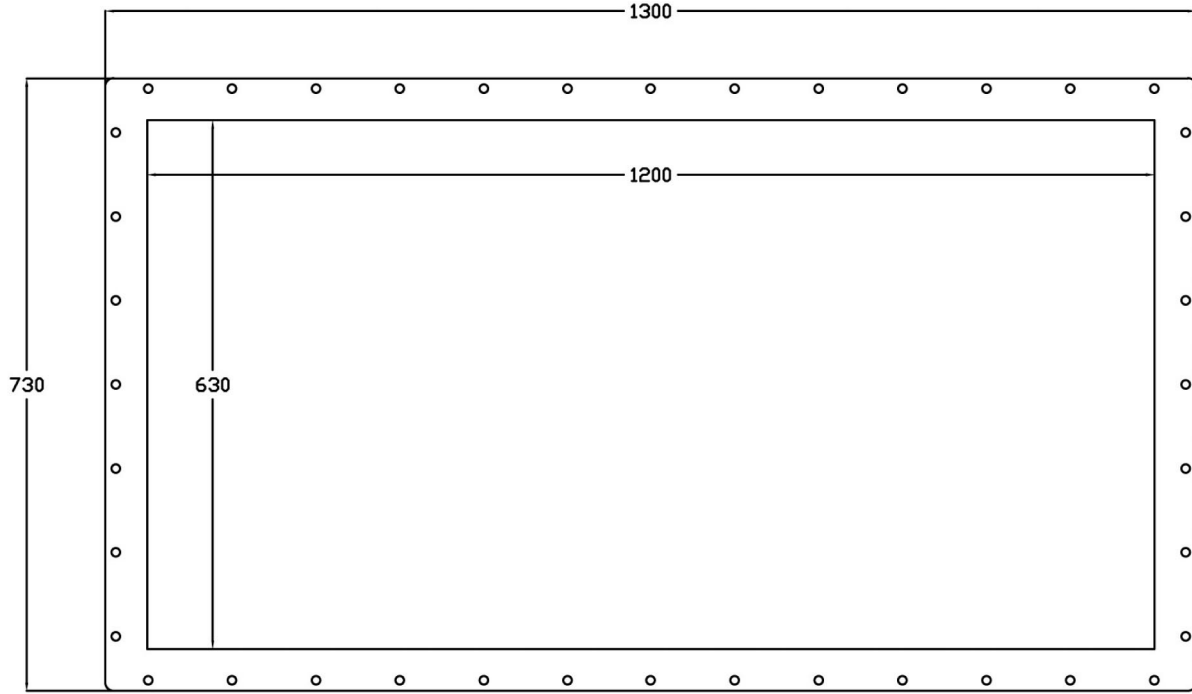

## ÖRNEK 5

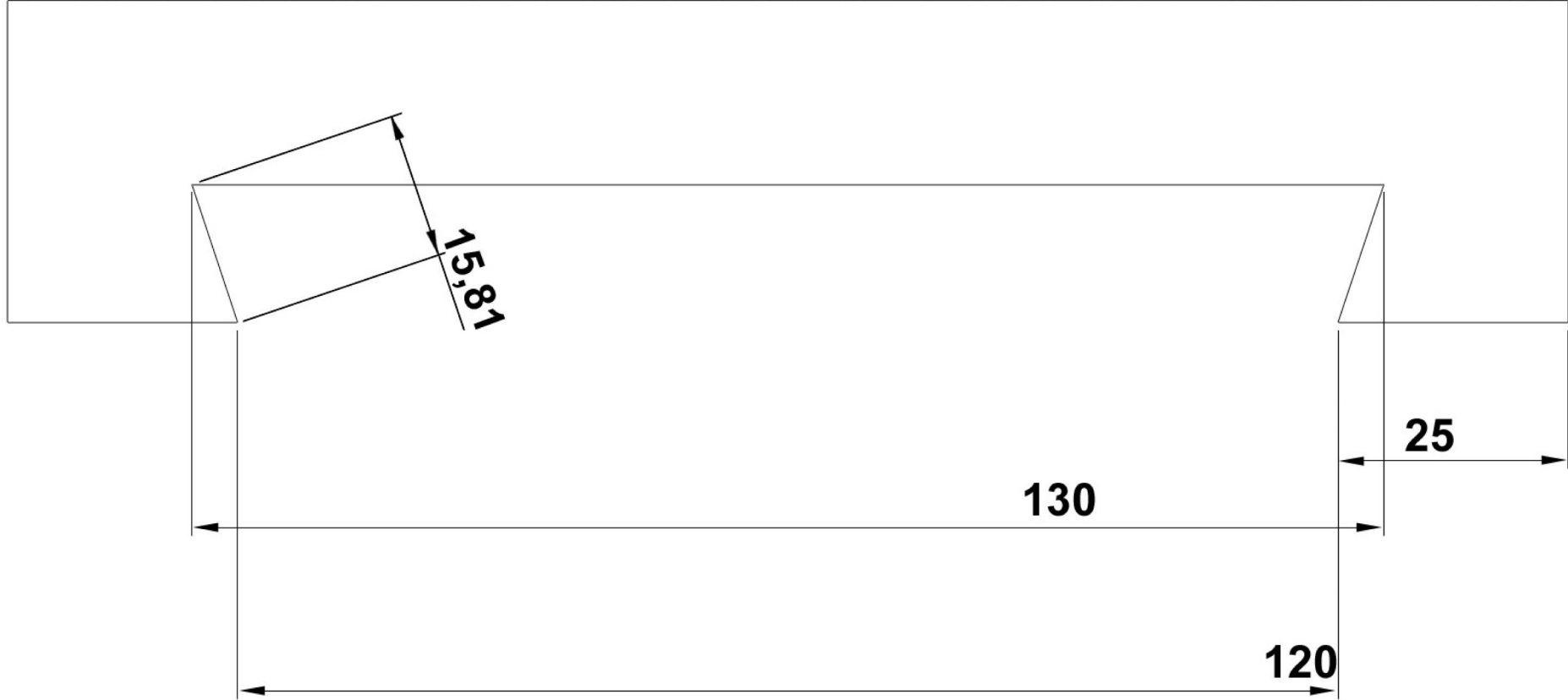

## ÖRNEK 6

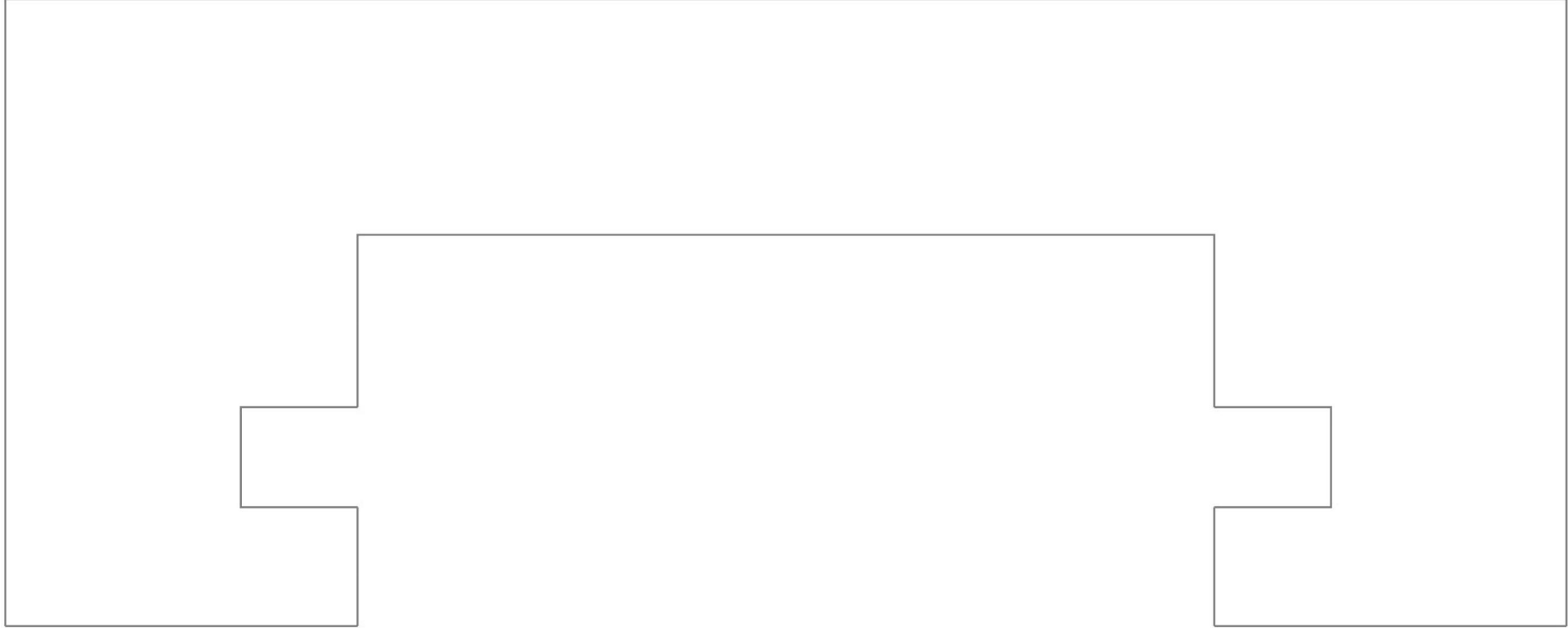

## ÖRNEK 7

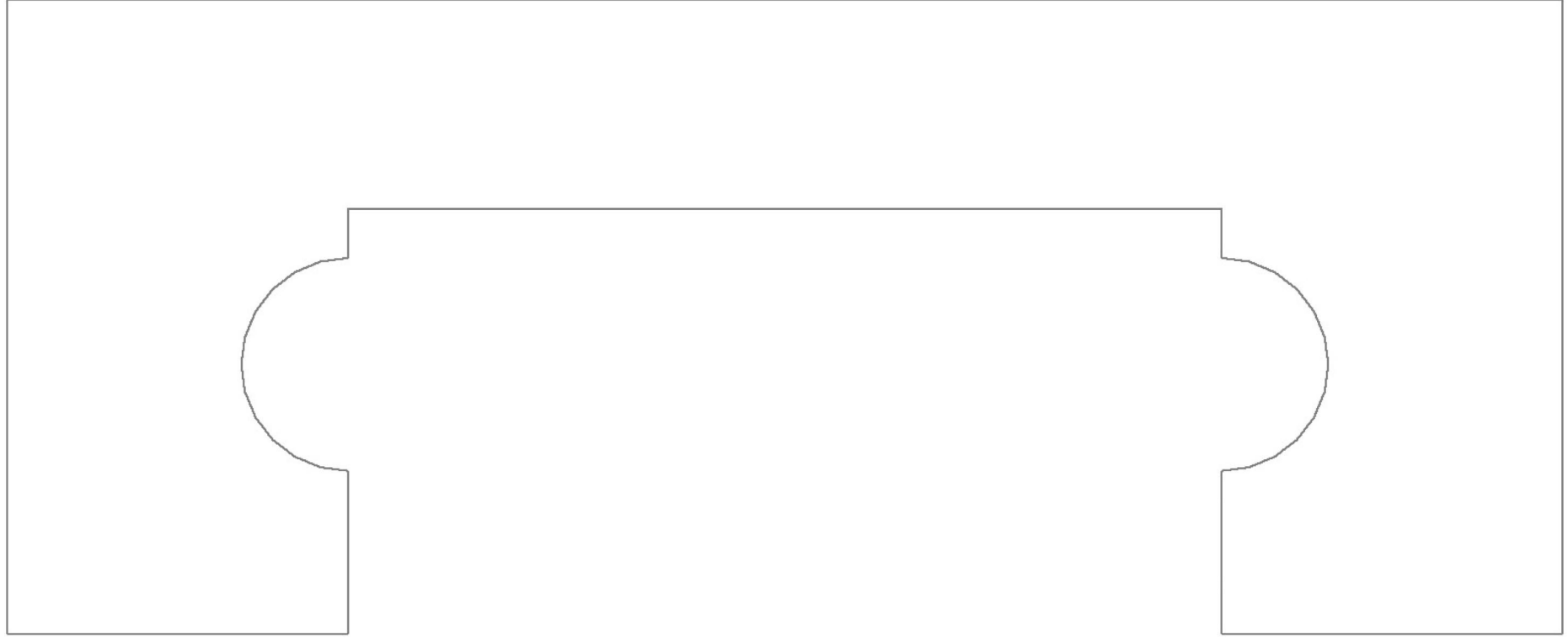

# ÖRNEK 8

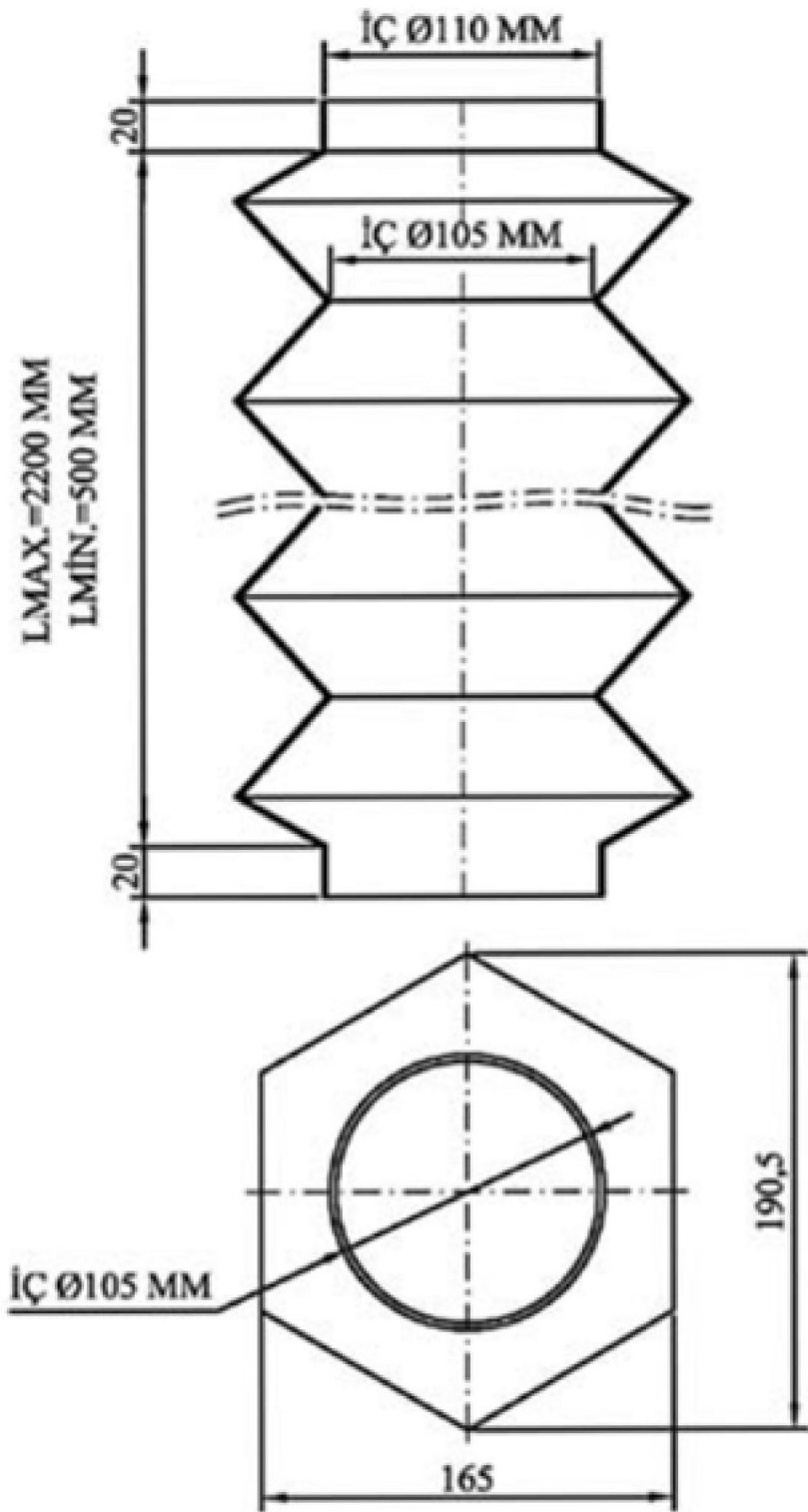

**KELEPÇELİ**





# ÖRNEK 9

Bağlantı Şekilleri:

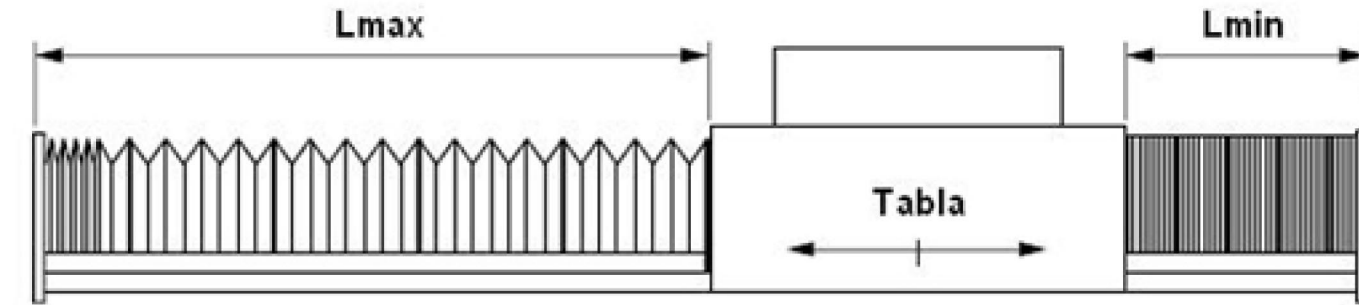
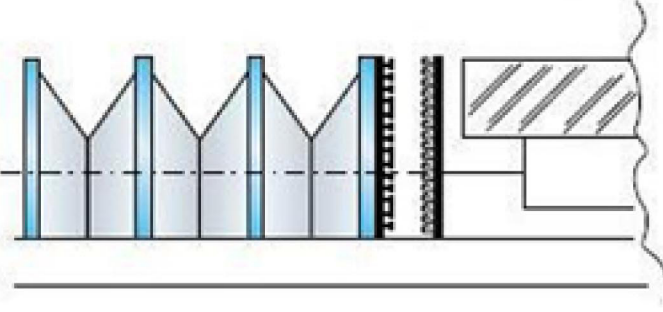
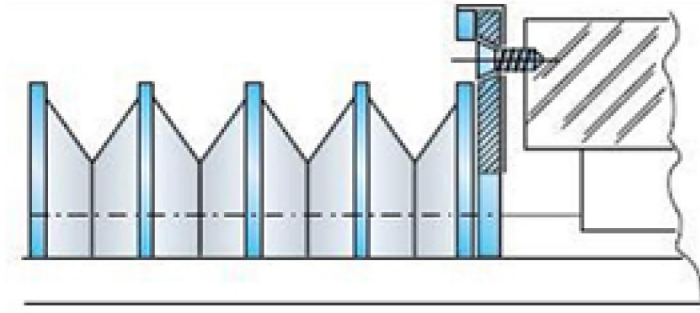
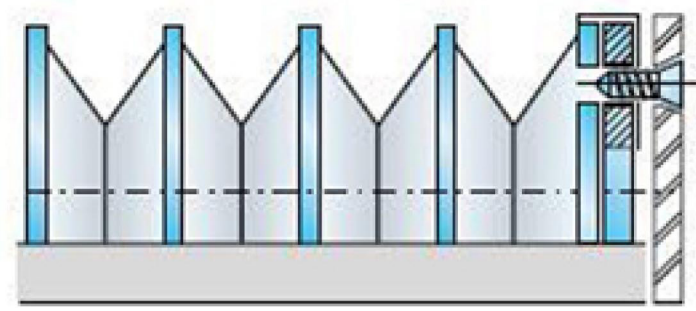
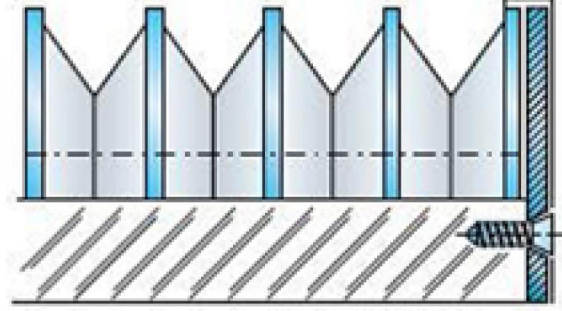
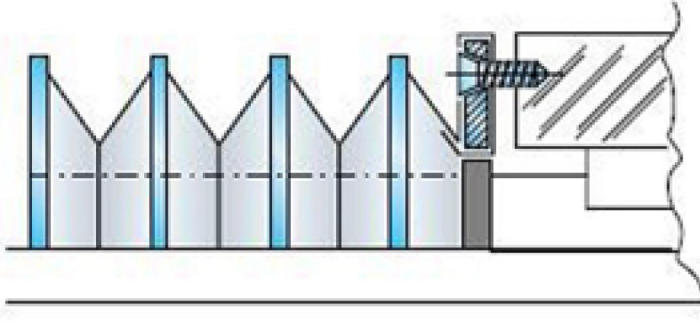

# ÖRNEK 10

## YUVARLAK DİKİŞLİ KÖRÜK

